

# mazda lamps

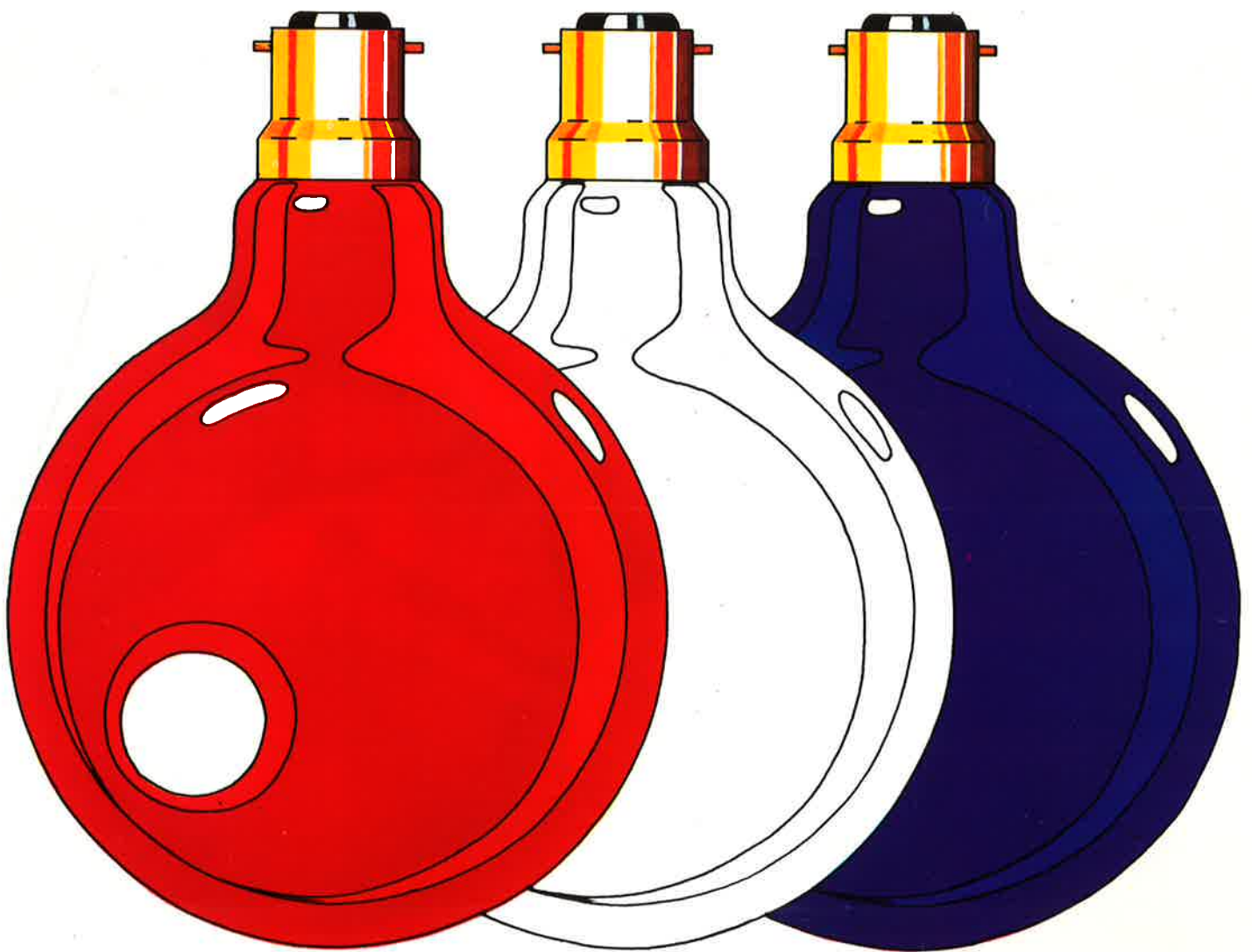

# mazda lamps

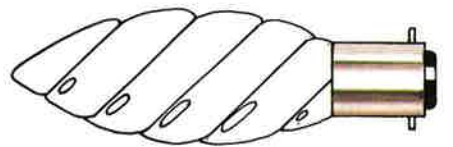
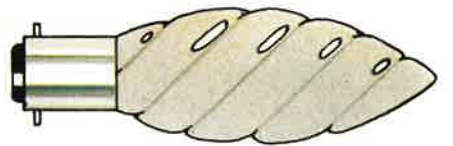
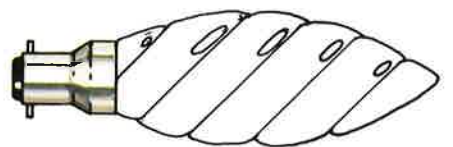
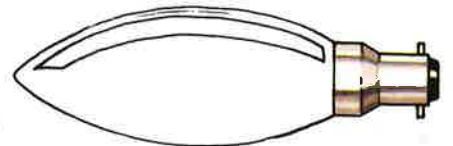
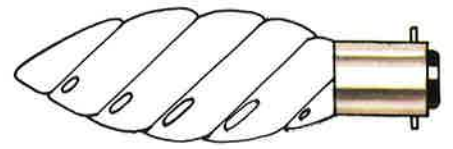
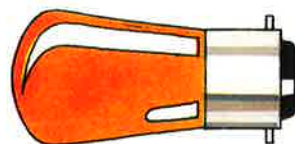
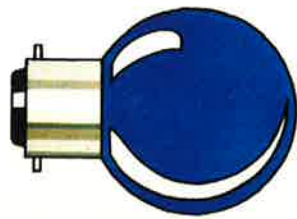
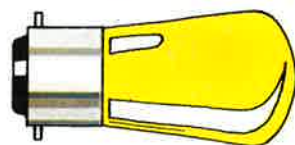
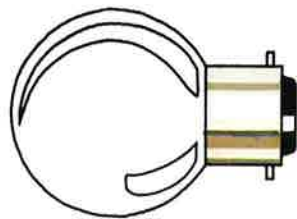
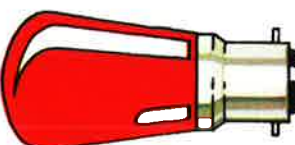
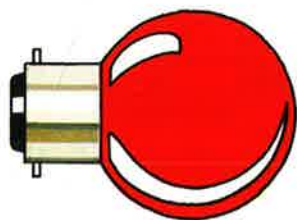
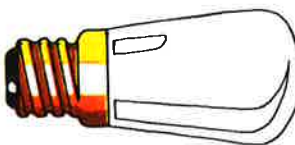
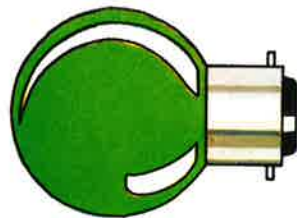
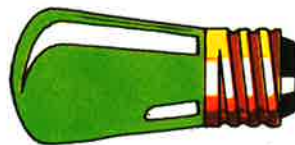
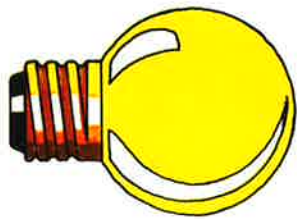
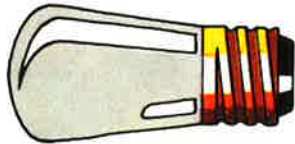

ROUND AND FESTIVE BULBS

PYGMY

PLAIN AND TWISTED CANDLES





DECOR ROUND LAMPS

PLUS LAMP

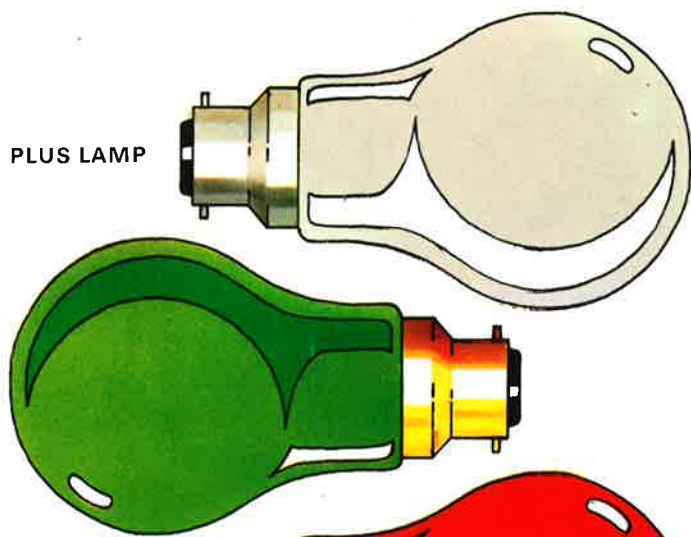

NETABULB

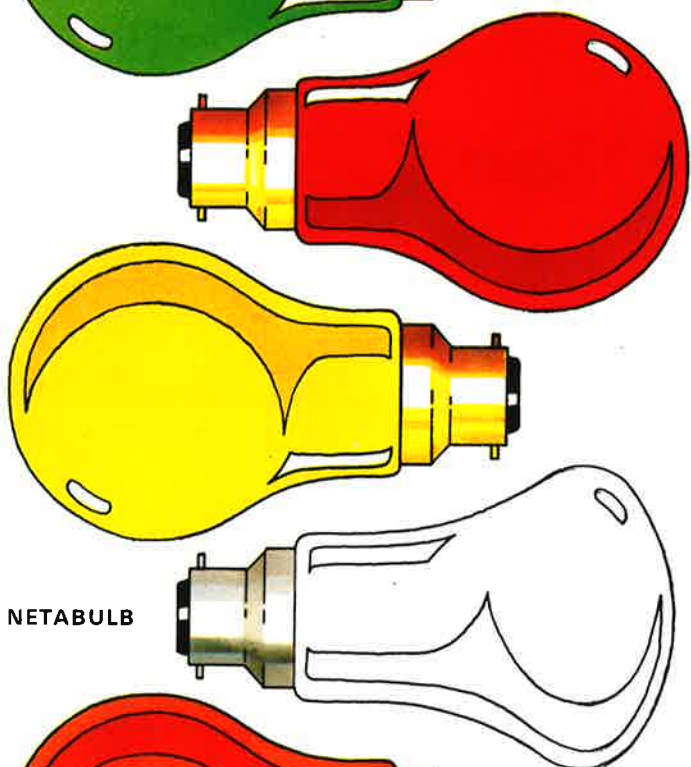

FIREGLOW

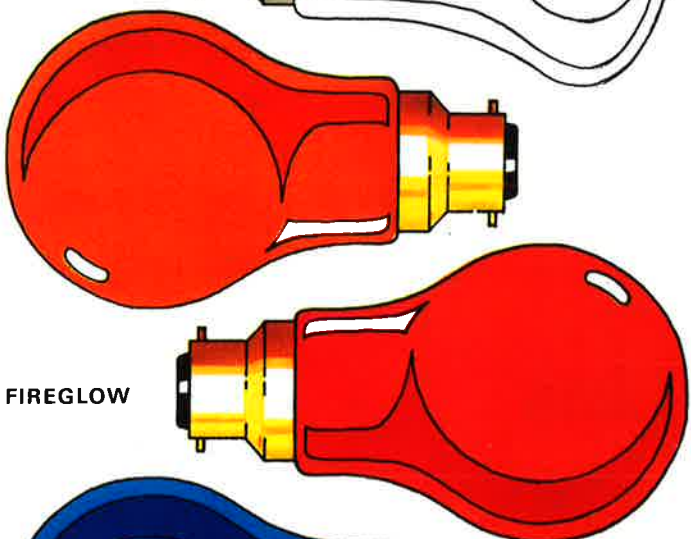

NIGHTLIGHT

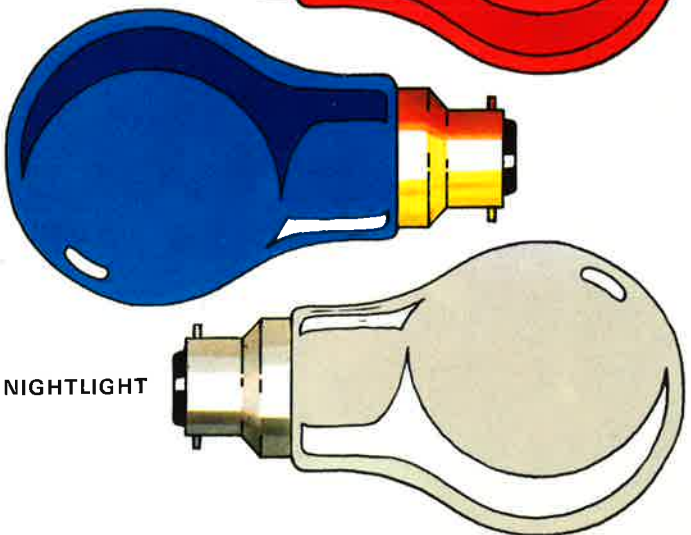

SINGLE CAP TUBULAR

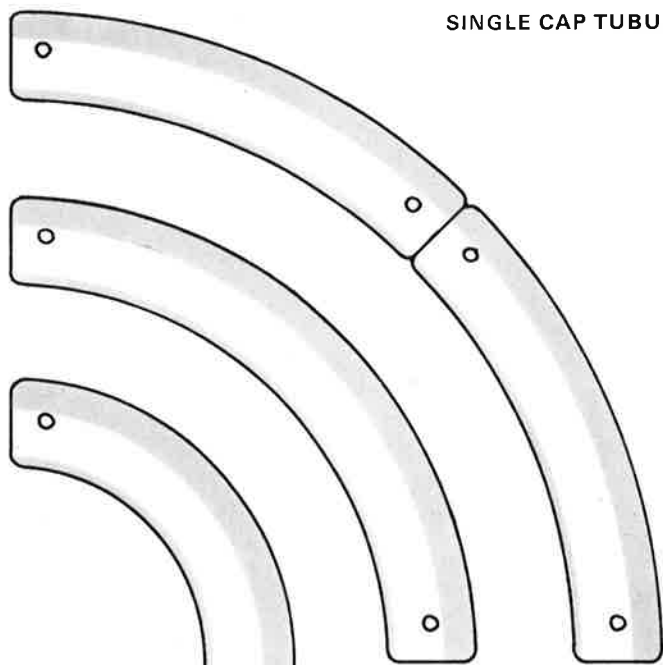

ARCHITECTURAL CURVED

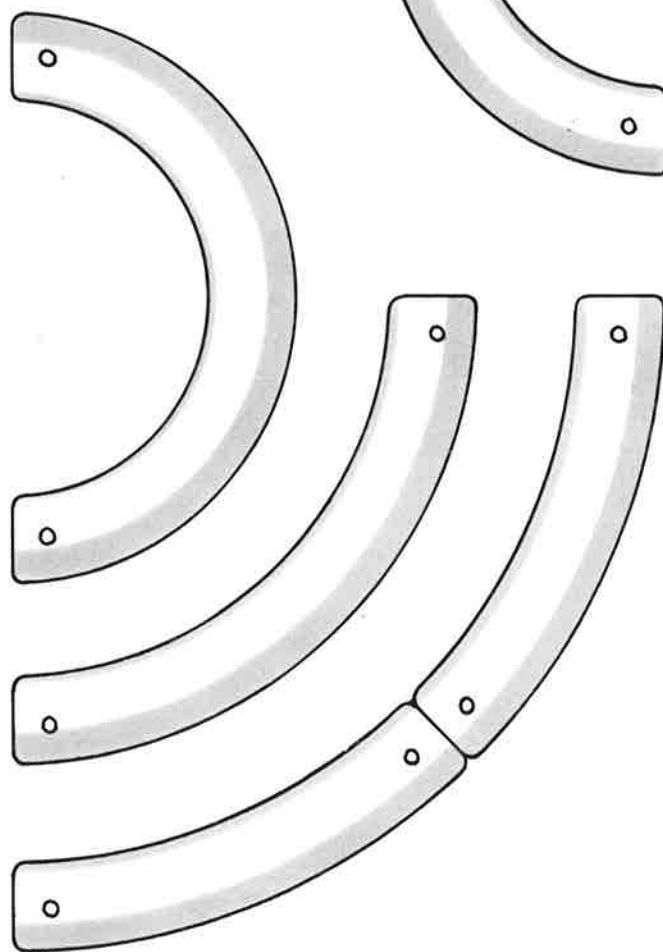
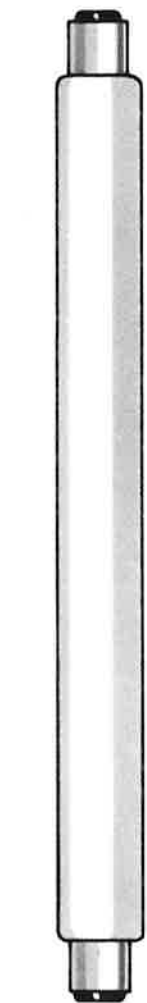
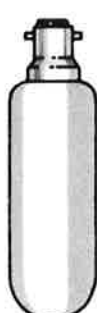
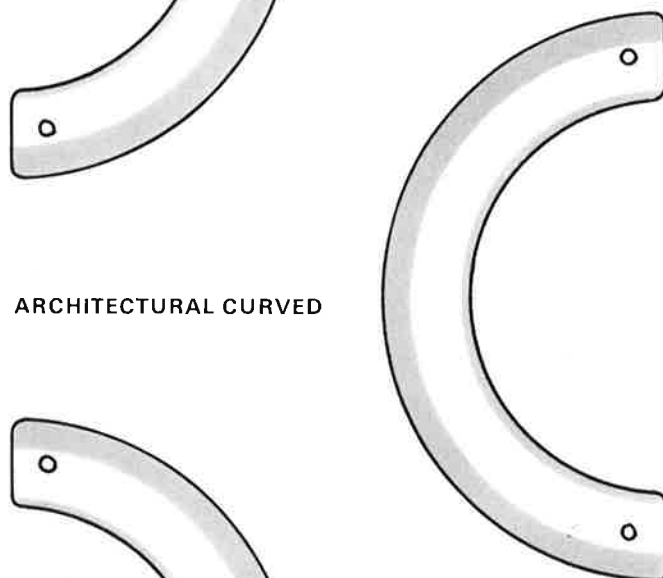

DOUBLE CAP TUBULAR

HOME-LITE

INTERIOR DISPLAY REFLECTOR LAMPS

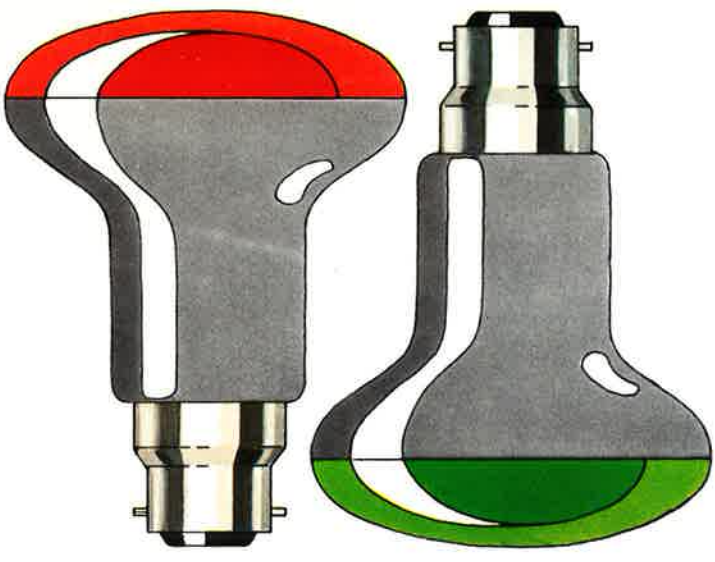

DECOR SPOT LAMPS

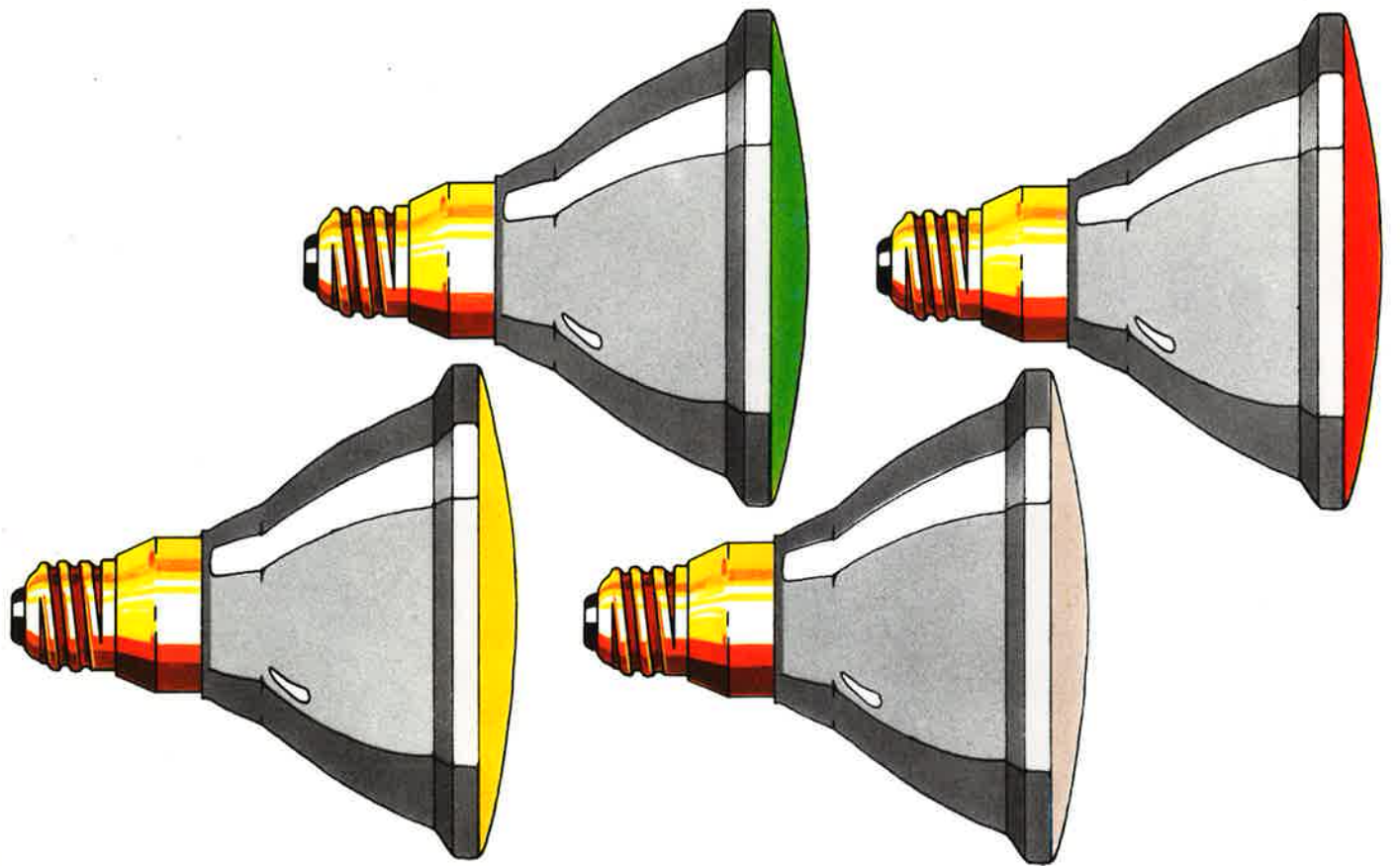
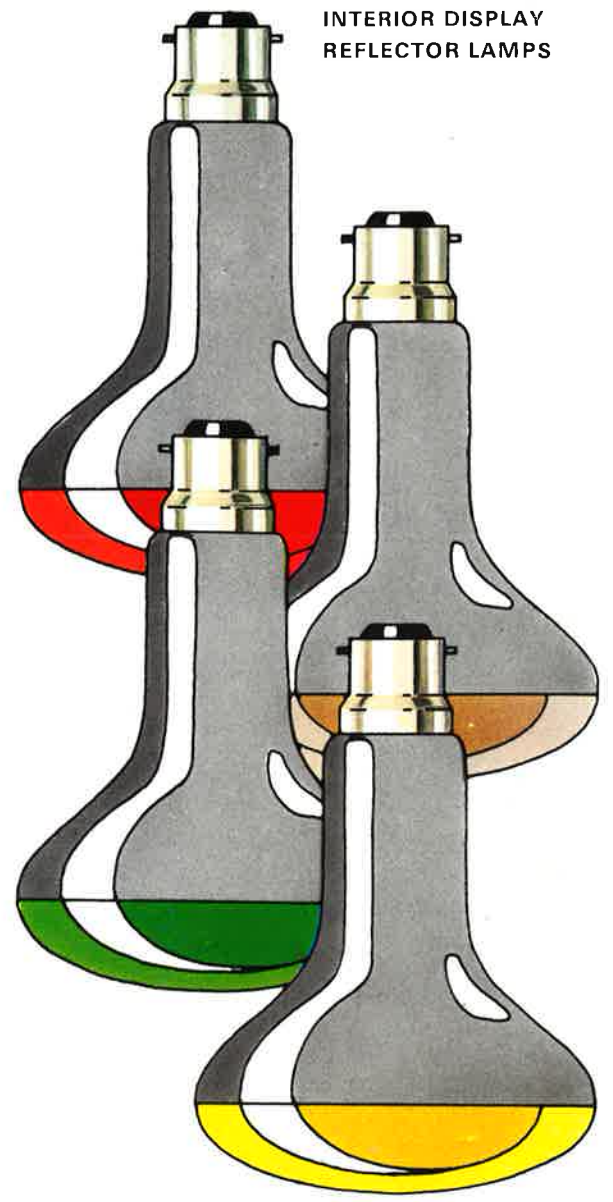
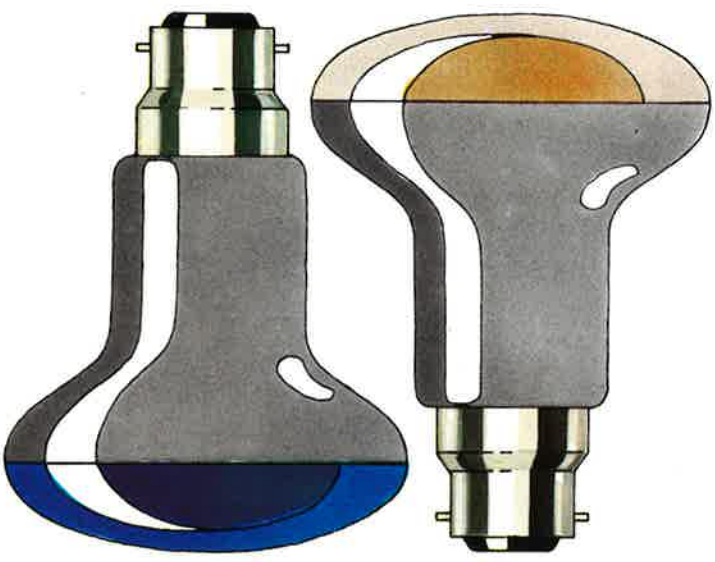

PAR 38 REFLECTOR LAMPS



## MAZDA LAMPS

WATTS	VOLTS	CAP	FINISH	STANDARD PACK	SELLING PRICE
-------	-------	-----	--------	---------------	---------------

### PLUS LAMPS – coiled coil

40	240	BC	Pearl & Clear	100
60	240	BC	Pearl & Clear	100
100	240	BC	Pearl & Clear	100
150	240	BC	Pearl & Clear	100

### NETABULB – coiled coil

40 & 60	240	BC	Silverlight	100
100	240	BC	Silverlight	100
150	240	BC	Silverlight	100

### NIGHTLIGHT

5-8	200/250	BC	Pearl	50*
-----	---------	----	-------	-----

### COLOURED GLS

15	200/250	BC, ES	Amber, blue, green, pink, red, white, yellow	100**
25	200/250	BC, ES	Amber, blue, green, pink, red, white, yellow	100**
40†	200/250	BC	Amber, blue, green, pink, red, yellow	100**
60†	200/250	BC	Amber, blue, green, pink, red, yellow	100**
60†	200/250	ES	Amber, blue, green, red, yellow	25
100†	200/250	BC	Amber, blue, green, pink, red, yellow	25
150†	200/250	BC	Amber, pink, red, yellow	25

†Not suitable for use outdoors unless enclosed for protection against rain

### GALA LIGHTING SET

A string of 12 waterproof lampholders for gala lamps.

Catalogue No AME 1809 Lamp Reference No. 30-9995

### GALA LIGHTING SET LAMPS COMPRISING THE FOLLOWING

25	200/250	BC	Amber, blue, green, pink, red, yellow	2 of each
----	---------	----	---------------------------------------	-----------

### ROUND BULB

25 & 40	240	BC, SBC, SES	Silverlight	50*
---------	-----	--------------	-------------	-----

### ROUND BULB FESTIVE

15 & 25	200/250	BC, ES	Amber, blue, green, red, white, yellow	50*
---------	---------	--------	--	-----

\*5 x 10-way packs per container

\*\*10 x 10-way packs per container

### PYGMY

15 or 25	200/250	ES, BC, SES, SBC	Clear	50*
15	200/250	BC, SBC, SES	Clear rough service	50*
25	200/250	BC, ES, SBC	Clear rough service	50*
15	200/250	BC, SBC	Amber, blue, green, pink, red, white, yellow	50*

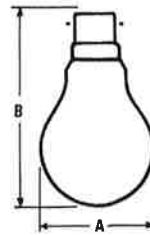

PLUS LAMP	A	B
40-100W	60	105
150W	68	125

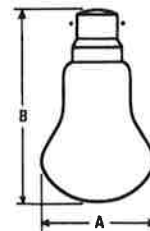

NETABULB	A	B
40-100W	60	100
150W	75	120

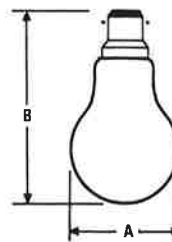

NIGHTLIGHT	A	B
5-8W	60	105

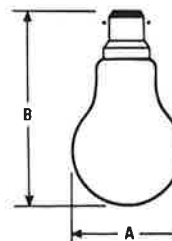

COLOURED GLS	A	B
15W-60W	60	105
100W	68	125
150W	80	160

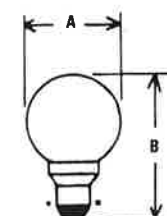

ROUND BULB	A	B
BC	45	65
SBC	45	71
SES	45	72
ES	45	69



PYGMY	A	B
BC	28	56
ES	28	58
SBC	28	62
SES	28	63

# MAZDA LAMPS

WATTS	VOLTS	CAP	FINISH	STANDARD PACK	SELLING PRICE
-------	-------	-----	--------	---------------	---------------

## DECOR ROUND LAMPS

40	240	BC, ES	Silverlight	10
60	240	BC, ES	Silverlight	10
40	240	BC, ES	Clear	10
40	240	BC, ES	Red, green, purple, amber	10
40	240	BC, ES	Crown silvered	10

## DECOR SPOT LAMPS – for indoor applications

40	240	BC, ES	Clear	10
60	240	BC, ES	Clear	10
40	240	BC, ES	Red, blue, green, yellow	10

## ATLAS INTERIOR DISPLAY REFLECTOR LAMPS

75	240	ES, BC	Blue, green, red yellow	10
75, 100 & 150	240	ES, BC	Clear	10

## ATLAS PAR 38 REFLECTOR LAMPS

100 & 150	240/250	ES	Clear-flood and spot	10
100	240/250	ES	Red, blue, green, yellow	10
150	240/250	ES	Cool Ray spot	10
150	240/250	ES	Red, blue, green, yellow	10

## FIREGLOW

60	200/250	BC	Lacquered	50*
60	200/250	3-pin BC	Lacquered	50*
60	200/250	2-prong	Lacquered	50*

## PLAIN CANDLE

25 & 40	240	BC, SBC, SES†	Clear, Silverlight	50*
25 & 40	240	BC, SBC	Pearl	50*
60	240	BC, SBC	Clear, Silverlight	50*
60	240	BC, SBC	Pearl	50*

†25W SES Available in Silverlight only

## COLOURED PLAIN CANDLE

25	240	BC only	Amber	50*
40	240	BC only	Amber	50*

## TWISTED CANDLE

25	240	BC, SBC	Clear	50*
25	240	BC, SBC	Pearl	50*
40	240	BC, SBC	Clear	50*
40	240	BC, SBC	Pearl	50*
60	240	BC, SBC	Clear	50*
60	240	BC, SBC	Pearl	50*

## COLOURED AND TIPPED TWISTED CANDLE

40	240	BC only	Amber tip, Pink tip	50*
60	240	BC only	Amber tip, Pink tip	50*

\*5 x 10-way packs per container

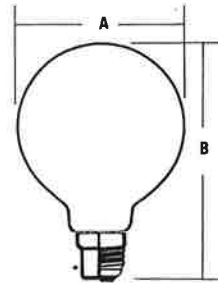

DECOR ROUND	A	B
40W & 60W BC	100	139
ES	100	141

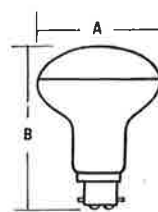

DECOR SPOT	A	B
40W & 60W Decor Spot	80	109

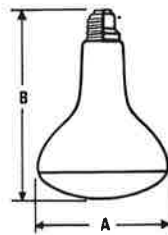

REFLECTOR DISPLAY	A	B
75-100W	95	135
150W	126	178

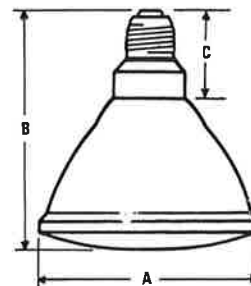

PAR 38 SEALED BEAM REFLECTOR	A	B	C
100W	121.5	135	51

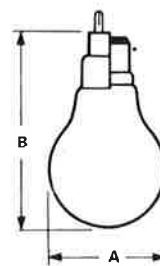

FIREGLOW	A	B
BC	60	105
3-pin BC	60	103
2-prong	60	113

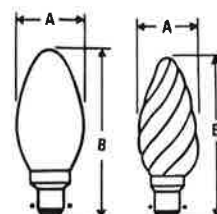

PLAIN CANDLE	A	B
25W-40W BC	35	92
SBC	35	98
SES	35	99
60W BC	45	123
SBC	45	128
TWISTED CANDLE	A	B
25W BC	35	95
SBC	35	99
40W-60W BC	46	123
SBC	46	128

# MAZDA LAMPS

WATTS	VOLTS	CAP	FINISH	STANDARD PACK	SELLING PRICE
-------	-------	-----	--------	---------------	---------------

## ARCHITECTURAL CURVED - $\frac{1}{8}$ , $\frac{1}{4}$ , $\frac{1}{2}$ circle

60	240/250	Peg	Opal	1	
----	---------	-----	------	---	--

## ARCHITECTURAL STRAIGHT - striplites

35	240/250	Peg	Opal	12"	1
53	240/250	Peg	Opal	18"	1
60	240/250	Peg	Opal	20"	1
60	240/250	DCC	Opal	20"	1
75	240/250	Peg	Opal	24"	1
110	240/250	Peg	Opal	36"	1
150	240/250	Peg	Opal	48"	1

## DOUBLE CAP TUBULAR - striplites (all in either 221mm or 284mm length)

30 or 60	240	Centre contact	Clear	25
30 or 60	240	Centre contact	Opal	25
30 or 60	240	Centre contact	Amber†	25

†Amber in 60W 284mm only

## SINGLE CAP TUBULAR

25	200/230	BC	Clear	50
25	240/250	BC, SBC	Clear	50
25	240/250	SES	Clear	50
40	240/250	BC, SBC	Clear	50
40 or 60	240/250	BC	Opal (Longlite)	25

# MAZDA TUBES

LENGTH	WATTS	SELLING PRICE	SELLING PRICE	SELLING PRICE
--------	-------	---------------	---------------	---------------

		White, Warm white	Natural	Home-lite
6ft	85	*	*	
5ft	65/80	*	*	*
4ft	40	*	*	*
2ft	20	*	*	
<b>1" DIAMETER</b>				
5ft	50	*	*	
3ft	30	*	*	
18"	15	*	*	

## MINIATURES

21"	13	*		
12"	8	*	*	
9"	6	*	*	
6"	4	*	*	

## CIRCLES - warm white only

16"	60	*		
16"	40	*		
12"	32	*		
8"	22	*		

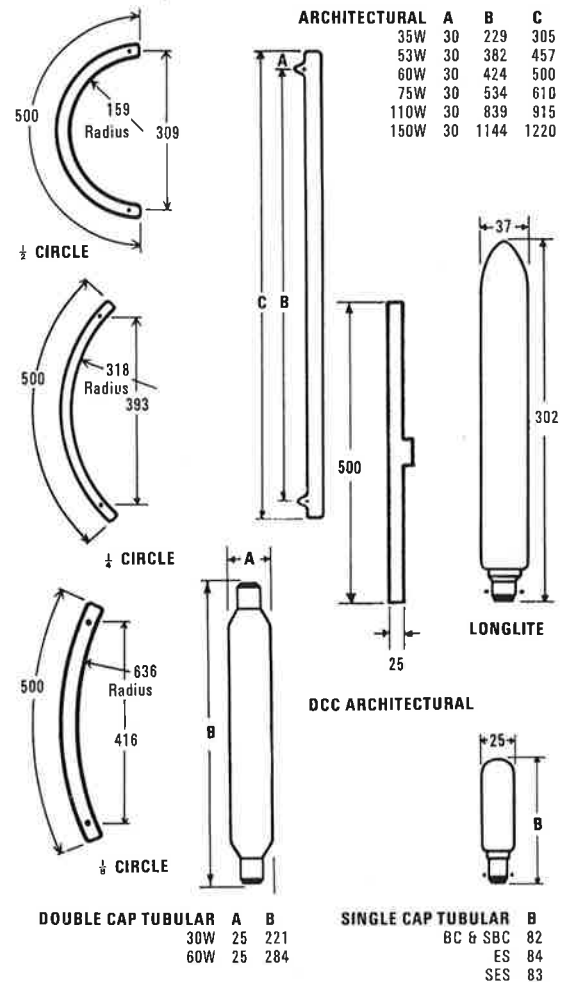

# THORN LIGHTING

## Thorn Lighting Limited UK Branches

**Belfast**  
Prince Regent Road, Castlereagh  
Belfast BT5 6QR  
Telephone 0232-54122  
Telex Thornlite Belfast 74695

**Birmingham**  
Thorn House, Aston Church Road  
Saltley Trading Estate, Birmingham B81 8E  
Telephone 021-327 1535  
Telex Thornlite Birmingham 33235

**Cardiff**  
Thorn House, Penarth Road  
Cardiff, Wales CF1 7YP  
Telephone 0222-44200  
Telex Thornlite Cardiff 49334

**Glasgow**  
Thorn House, Lawmoor Street  
Glasgow G5 0TT  
Telephone 041-429 6222  
Telex Thornlite Glasgow 77630

**Leeds**  
Thorn House, 3 Ring Road  
Lower Wortley, Leeds LS12 6EJ  
Telephone 0532-638321  
Telex Thornlite Leeds 55110

**London**  
Victoria Trading Estate, Victoria Way  
Charlton, London SE7 7PA  
Telephone 01-858 3201 (order office) or  
01-858 3281 (all other enquiries)  
Telex Thornlite Charlton 896171  
Angel Road Works, 402 Angel Road  
Edmonton, London N18 3BP  
Telephone 01-807 3050  
Telex Thornlite Edmonton 23167

**Manchester**  
Thorn House, 2 Claytonbrook Road  
Clayton, Manchester M11 1BP  
Telephone 061-223 1322  
Telex Thornlite Manchester 668642

**Reading**  
10 Richfield Avenue, Reading, Berks  
Telephone 0734-53257

**Southampton**  
West Quay Trading Estate, West Quay Road  
Southampton SO9 1FF  
Telephone 0703-27401

**Government Contracts & Order Office**  
Telephone 01-363 5353

**Head Office and Showroom**  
Thorn House, Upper Saint Martin's Lane  
London WC2H 9ED  
Telephone 01-836 2444  
Telex Thorn London 24184/5

Thorn Lighting Limited is constantly developing and improving its products. All descriptions, illustrations, drawings and specifications in this publication present only general particulars and shall not form part of any contract. The right is reserved to change specifications without prior notification or public announcement. The majority of the products described herein are manufactured in the United Kingdom, products not so manufactured will bear an appropriate indication.